



Florida Department of Transportation

RICK SCOTT
GOVERNOR

605 Suwannee Street
Tallahassee, FL 32399-0450

ANANTH PRASAD, P.E.
SECRETARY

STRUCTURES DESIGN BULLETIN C11-07 **ROADWAY DESIGN BULLETIN 11-07**

DATE: June 30, 2011

TO: District Directors of Production, District Design Engineers, District Structures Design Engineers

FROM: Robert V. Robertson, P. E., State Structures Design Engineer
David O'Hagan, P.E., State Roadway Design Engineer

COPIES: Brian Blanchard, Tom Andres, Charles Boyd, Jeffrey Ger (FHWA), Derek Soden (FHWA)

SUBJECT: Incorporation of Prefabricated Steel Truss Pedestrian Bridges in FDOT Bid Documents

REQUIREMENTS

Plans Preparation Manual, Volume 1

1. Insert sub-article heading 8.7.1 below the first paragraph in Article 8.7 as follows:

8.7.1 Design Criteria

2. Insert sub-article 8.7.2 below Figure 8.1 as follows:

8.7.2 Prefabricated Steel Truss Pedestrian Bridges on FDOT Projects

In many situations it makes good engineering and economic sense to utilize prefabricated steel truss bridges for pedestrian crossings. These bridges can be stand-alone structures or a hybrid structure with adjoining spans of other types (FIB, deck slab, steel I-girder, etc.). The provisions of this article apply only to the spans on a bridge that are comprised of prefabricated steel trusses. The term steel truss bridge as applied in this article refers only to stand-alone steel truss structures or to the steel truss spans of a hybrid bridge structure.

The Department may elect to use prefabricated truss bridges on FDOT projects if the following conditions are met:

1. The steel truss span lies within a tangent horizontal alignment.
2. The maximum length of the steel truss span does not exceed 200 feet.
3. The width of the steel truss span is constant.
4. The steel truss span supports have a skew angle not to exceed 20°.

When these criteria are not met provide a complete set of bridge details in the plans.

8.7.2.1 Qualification of Prefabricated Steel Truss Pedestrian Bridge Producers

All prefabricated steel truss pedestrian bridge producers wanting to participate on FDOT projects must be on the Department's List of Qualified Metal Fabrication Facilities. For information on the facility qualification process see articles 11.1.5 and 11.1.6 of the FDOT Materials Manual:

[\[http://www.dot.state.fl.us/statematerialsoffice/administration/resources/library/publications/materialsmanual/index.shtm\]](http://www.dot.state.fl.us/statematerialsoffice/administration/resources/library/publications/materialsmanual/index.shtm).

8.7.2.2 Design and Detailing Responsibilities

The project EOR will be responsible for design and detailing of the steel truss bridge substructure and foundation including end bents, piers, pile foundations, and/or spread footings. The project EOR will also be responsible for design and detailing of all approach structures (non-steel truss bridge spans, walls, ramps, steps, approach slabs, etc.).

The Contractor's EOR will be responsible for the design and detailing of the steel truss bridge superstructure including trusses, deck, bridge railing, floor beams, bridge joints, bearing assemblies and anchor bolts.

8.7.2.3 Plans Development

To allow equal opportunity for all qualified pedestrian bridge producers to participate, the pedestrian bridge plans shall have the flexibility to accommodate multiple alternate superstructure designs. When a prefabricated steel truss pedestrian bridge is warranted, the following procedure shall be followed by the project EOR when developing the plans:

1. Using Figures 8.2, 8.3, and 8.4, coordinate with the District Project Manager to select all allowable truss configurations, truss member shapes, and bridge cross-sections. Note that for spans greater than 150 feet a box truss bridge cross-section is required.

If project specific aesthetic requirements warrant the use of truss configurations not included in Figure 8.2 the project EOR can specify additional truss configurations. However, a minimum of two steel truss pedestrian bridge producers shall be capable of satisfying the aesthetic requirements.

2. Develop a Plan and Elevation sheet and Bridge Typical Section to be submitted with the BDR/30% plans.

3. After the BDR/30% plans have been approved send out a Prefabricated Pedestrian Bridge Invitation to Participate (ITP) to all prefabricated pedestrian steel truss bridge producers on the Department's List of Qualified Fabrication Facilities. The ITP shall be sent through registered mail with return receipt to confirm delivery. Contact information for all qualified producers can be found at the following web address:

[\[http://www.dot.state.fl.us/statematerialsoffice/quality/programs/qualitycontrol/materialslistings/sources/metalsource.pdf\]](http://www.dot.state.fl.us/statematerialsoffice/quality/programs/qualitycontrol/materialslistings/sources/metalsource.pdf).

The ITP is intended to solicit qualified producers for information required to design the foundation and substructure of the steel truss pedestrian bridge. The ITP cover letter should contain the following elements with links to websites as appropriate and applicable:

- Introduction with brief project description
- Project Requirements
 - Design Specifications Requirements
 - Construction Specifications Requirements
 - Design Standards Requirements
 - Bridge Typical Section
 - Allowable Truss Options
 - Painting Requirements
 - Pedestrian Fence/Railing Requirements
 - Vehicular Loading Requirements
 - Project Specific Aesthetic Requirements (if applicable)
 - Project Geometry including Vertical Clearance Requirements for Each Span
- Participation Requirements
- Submittal Requirements

Include the following items in the ITP package:

- Hard copy:
 - Invitation to Participate Cover Letter
 - Project Location Map
 - Plan and Elevation
 - Bridge Typical Section and Pedestrian Fence Concept
 - Pedestrian Bridge Data Sheet
- Electronic files:
 - PDF file with all of the above
 - Pedestrian Bridge Data Sheet in Microstation (DGN) and AutoCAD (DWG) formats
 - PEDDS Partial Project (to facilitate electronic signing and sealing)

For a sample Prefabricated Pedestrian Bridge ITP complete with all hard copy attachments see Exhibit 8-A. To aid plan development CADD cells for the Pedestrian Bridge Data Sheet, and Plan and Elevation sheet (2 of 2) are available in the FDOT Structures Cell Library. For the current FDOT CADD Software downloads follow the link below:

[<http://www.dot.state.fl.us/ecso/downloads/software/FDOT2010CaddSoftware.shtm>]

4. Upon delivery the pedestrian bridge producers shall acknowledge receipt of the ITP package.
5. In order to be eligible to participate in the project the pedestrian bridge producers must provide a completed Pedestrian Bridge Data Sheet as outlined in the ITP on or before the specified due date (prior to 60% plans submittal). The completed Data Sheets shall be electronically signed and sealed by the Contractor's EOR for inclusion in the final plan set.

The project EOR shall assign a unique sheet number to each data sheet. The sheet numbers will be identified with the prefix BP (e.g. BP-1, BP-2, ... BP-#) and the data sheets will be placed at the end of the numbered sequence of the bridge plans. This will allow the Pedestrian Bridge Data Sheets to have constant (un-changing) sheet numbers as plan development progresses. To facilitate completion and electronic signing and sealing of the Pedestrian Bridge Data Sheet by the Contractor's EOR, the project EOR shall create a PEDDS Partial Project and include it with the ITP. For instructions on creating and working with Partial Projects follow the link below to the PEDDS on line help file:

[<http://www.dot.state.fl.us/ecso/downloads/publications/applications/pedds/help/partialproject.shtm>]

6. After all ITP responses are received the project EOR shall design and detail the foundation and substructure to accommodate the superstructure designs of all eligible pedestrian bridge producers. Design shall envelope the most extreme loading conditions and geometry of all alternates.

7. Include the following notes in the plans:

- Eligible Steel Truss Pedestrian Bridge Producers

Included in this plan set are Pedestrian Bridge Data Sheets submitted by bridge producers eligible to participate in this project. Producers who failed to submit a data sheet are excluded from participation. No Cost Savings Initiative Proposal shall be accepted for the truss superstructure portion of the project. Contact information for the eligible producers is included in the data sheet.

- Shop Drawing Submittal

Prior to fabrication the Contractor's EOR shall submit signed and sealed superstructure shop drawings, technical specifications, and design calculations to the Engineer for review and approval.

8. Include the following Pay Item note in the plans:

- Prefabricated Steel Truss Pedestrian Bridge Span

Prefabricated Steel Truss Pedestrian Bridge Span shall be paid for at the contract unit price per square foot of deck area under Pay Item No. 460-7 Prefabricated Steel Truss Pedestrian

Bridge, SF. This pay item includes furnishing and installing the prefabricated steel truss pedestrian bridge superstructure including steel trusses, floor system, deck, bearing assemblies, deck joints, and bridge railing/fencing. Payment for this pay item shall be based on the plan quantity. Portions of pedestrian bridge outside the limits of the steel truss span shall be paid for under individual pay items.

Figure 8.2 Prefabricated Pedestrian Bridge Standard Truss Configurations

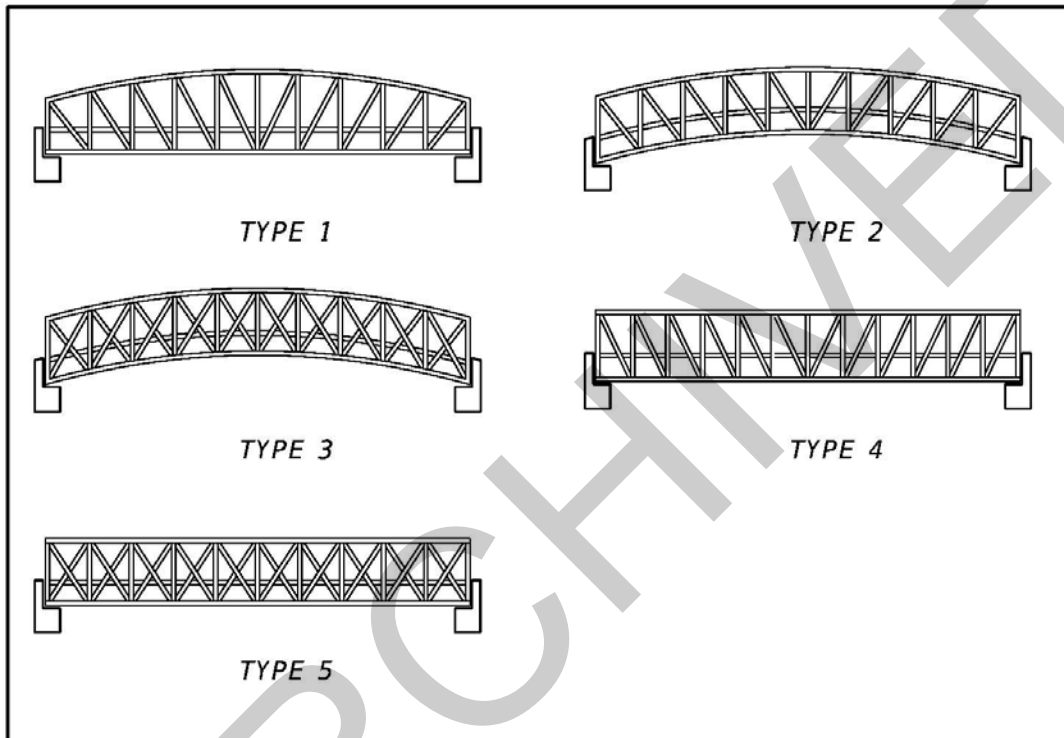

Figure 8.3 Prefabricated Pedestrian Bridge Standard Truss Member Shapes

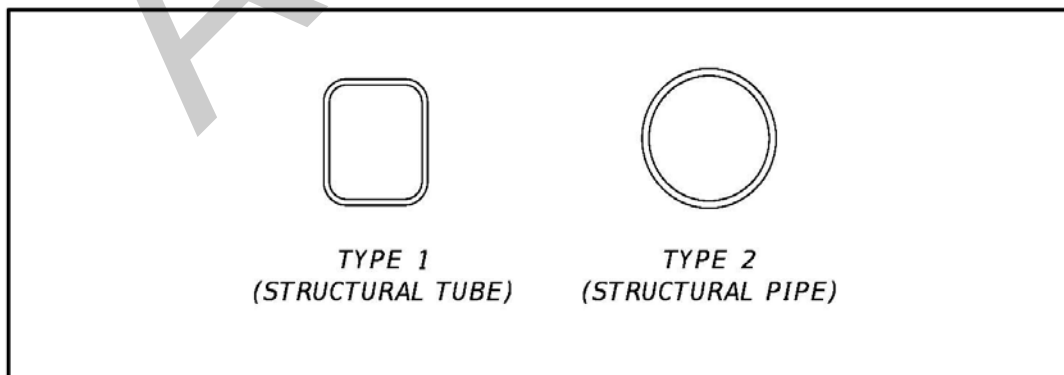
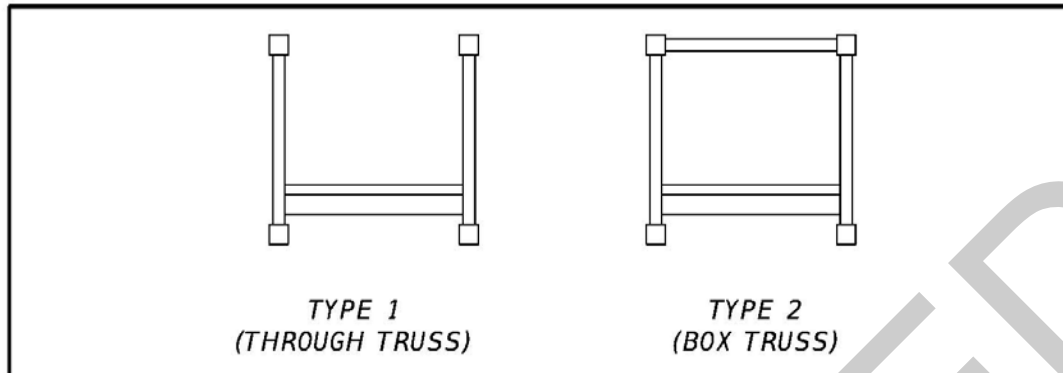

Figure 8.4 Prefabricated Pedestrian Standard Bridge Cross-Sections



Through Truss is limited to spans lengths less than 150 feet.

3. Insert Exhibit 8-A (attached) at the end of PPM Volume 1, Chapter 8.

Structures Design Guidelines

1. Replace Section 10.3.B with the following:
 - B. For FDOT projects, engineering design firms working directly for the FDOT or Contractor's EORs designing prefabricated steel truss pedestrian bridges meeting the requirements of PPM, Volume 1, Article 8.7.2 shall be pre-qualified in accordance with [Rule 14-75](#), work group 4.2.2.
2. Replace Section 10.4 as follows:

10.4 DESIGN

 - A All pedestrian bridge structures shall be designed in accordance with the following:
 - AASHTO LRFD Bridge Design Specifications (AASHTO)
 - AASHTO Guide Specifications for the Design of Pedestrian Bridges (Guide Spec.)
 - FDOT Plans Preparation Manual (PPM)
 - FDOT Structures Manual
 - B. Prefabricated Steel Truss Pedestrian Bridges meeting the requirements of PPM, Volume 1, Section 8.7.2 shall be designed and detailed as follows:
 1. Fully design and detail foundation and substructure in the plans.
 2. Fully design and detail all approach structures including non-truss approach spans, ramps, steps/stairways, approach slabs, retaining walls, etc. in the plans.
 3. Include general plan and elevation indicating minimum aesthetic requirements for the prefabricated steel truss bridge in the plans (see PPM, Volume 1, Appendix 8-1).

4. Prefabricated steel truss superstructure is to be designed and detailed by the Contractor's EOR after award of the contract. Design calculations, technical specifications, and fully detailed shop drawing are to be submitted to the Engineer for review and approval prior to fabrication. Components to be included in the shop drawings include trusses, floor system, lateral bracing, deck, railing/fencing, deck joints, bearing assemblies, etc.
 - C. It is desirable to limit the maximum overall width of prefabricated steel truss bridges to 12 feet. This will eliminate the need for a spliced section.
 - D. Pedestrian bridges not meeting the requirements of PPM, Volume 1, Article 8.7.2 shall be custom designed and fully detailed in the plans.
 - E. Design all pedestrian bridges for a 75 year design life.
 - F. Clearance criteria for pedestrian bridges shall be as follows:
 1. Vertical clearance criteria shall be as per the current PPM, Volume 1, Table 2.10.1
 2. Pedestrian bridges that accommodate horse travel shall have a minimum of 12 feet vertical clearance above the bridge deck.
 3. Horizontal clearance shall be in accordance with PPM, Volume 1, Article 2.11. Horizontal clearance shall take into account future widening of the roadway below.
 - G. Camber DL/LL Deflections – Contrary to Guide Spec. [5] use the following to determine maximum deflections for pedestrian bridges:
 1. Pedestrian LoadSpan/500
 2. Truck LoadSpan/500
 3. Cantilever arms due to service pedestrian live loadCantilever Length/300
 4. Horizontal deflection due to lateral wind loadSpan/500
 5. The pedestrian bridge shall be built to match the plan profile grade after all permanent dead load has been applied.
 - H. The minimum pile size for pedestrian bridges is 14-inch square piling. However, the provisions of Section 3.5.1.F.3 still apply.
 - I. When determining the capacity of reinforced concrete decks, capacity due to stay-in-place forms shall be disregarded.
3. Replace Section 10.6.C with the following:
 - C. Specify ASTM A500 Grade B or C or ASTM A847 for structural tubing: Minimum thickness shall be 1/4" for primary members and 3/16" for verticals and diagonals.
 4. Replace Section 10.6.D with the following:
 - D. Obtain approval from the Department prior to specifying unpainted weathering steel.

5. Replace Section 10.7.D.2 with the following:
 2. Prior to bolting of field sections tubular members shall be capped and fully sealed with the following exception. Weep holes shall be provided at the low point of all members to allow for drainage of water accumulated inside the members during transport and erection. After erection is complete and prior to painting, the weep holes shall be sealed with silicone plugs.
6. Delete Section 10.7.D.4
7. Delete Section 10.18.
8. Expand Table 3.5.12-1 as follows:

Table 3.5.12-1 Maximum Pile driving Resistance

Pile Size	Resistance (tons)
*14 inch	200
18 inch	300
20 inch	360
24 inch	450
30 inch	600
54 inch concrete cylinder	1550
60 inch concrete cylinder	2000

*14 inch square piles can only be used in pedestrian bridge applications

COMMENTARY

The primary reason for this new policy is to improve the efficiency of the design process by eliminating design and detailing requirements for pedestrian bridges that are subsequently redesigned by the Contractor’s EOR. This policy will save time and money in the design phase of pedestrian bridge projects by eliminating the current requirement of providing custom design plans for all pedestrian bridges.

BACKGROUND

Current policy requires all pedestrian bridges on FDOT projects to be custom designed and fully detailed in the plans prior to bid. After the contract is awarded the contractor has the option to propose a prefabricated steel truss pedestrian bridge in lieu of the custom designed bridge shown in the plans. In the vast majority of cases the contractor disregards the custom designed plans and chooses to provide the prefabricated steel truss option. The time and effort required to develop the custom plans is largely wasted since custom designs are rarely used in the final project.

The new policy saves the Department time and money by eliminating the requirement for custom pedestrian bridge designs to be developed and included in the plans prior to bid and allows the contractor to select a prefabricated steel truss pedestrian bridge directly. The new policy also establishes standard parameters to define minimum aesthetic requirements for prefabricated steel truss pedestrian bridges.

IMPLEMENTATION

These requirements are effective for all projects in the BDR stage as of January 1, 2012 and all future projects.

CONTACT

Tom Andres, P.E.
Assistant State Structures Design Engineer
Florida Department of Transportation
605 Suwannee Street, MS 33
Tallahassee, FL 32399-0450
Phone (850)-414-4269
Thomas.Andres@dot.state.fl.us

Attachment

ARCHIVED

EXHIBIT 8-A

Sample Prefabricated Pedestrian Bridge Invitation to Participate

ARCHIVED



Florida Department of Transportation

RICK SCOTT
GOVERNOR

605 Suwannee Street
Tallahassee, FL 32399-0450

ANANTH PRASAD, P.E.
SECRETARY

FLORIDA DEPARTMENT OF TRANSPORTATION

DISTRICT 3

PREFABRICATED PEDESTRIAN BRIDGE

INVITATION TO PARTICIPATE

Project: CR 250 over Ruby Creek Pedestrian Bridge

Financial Project Number: 217664-1-52-01

Federal Aid Project Number(s): SF2-349-R

Date: March 15, 2011

Introduction:

The Florida Department of Transportation is currently preparing bid documents for the construction of a steel truss pedestrian bridge adjacent to County Road 250 crossing Ruby Creek in Jefferson County. The superstructure of the proposed bridge is to be provided by a steel truss pedestrian bridge producer who is prequalified to work on FDOT projects. This invitation to participate is being sent to all prequalified producers to solicit information needed by the project EOR to design the foundation and substructure of the proposed bridge. Enclosed are the following materials:

- **Hard Copy**
 - Project location map
 - Bridge Typical Section and Pedestrian Fence Concept
 - Plan and Elevation (P&E) (2 sheets)
 - Pedestrian Bridge Data Sheet
- **Electronic**
 - PDF file with all of the above
 - Pedestrian Bridge Data Sheet in MicroStation (DGN) format
 - PEDDS Partial Project file (for electronic sign and seal)

Project Requirements:

1. Design Specifications: as specified in FDOT Structures Design Guidelines (SDG) Article 10.4.
<http://www.dot.state.fl.us/structures/StructuresManual/CurrentRelease/StructuresManual.shtm>
2. Construction Specifications:
FDOT Standard Specifications for Road and Bridge Construction, current edition.
<http://www.dot.state.fl.us/specificationsoffice/Default.shtm>
3. Design Standards:
FDOT Design Standards, current edition.
<http://www.dot.state.fl.us/rddesign/DesignStandards/Standards.shtm>
4. Allowable Truss Options: All allowable Truss options are indicated on P&E sheet 2 of 2 (Attached).
5. Paint: All structural steel shall be painted in accordance with Sections 560 and 975 of the Specifications. All structural steel shall be painted with a high performance top coat system. The color of the finish coat shall conform to Federal Standard No. 595, Color No. 36622.
6. Pedestrian Fence: Bridge Fence consistent with bridge rail concept and SDG Article 10.12.
7. Vehicular Loading: Vehicular Loading per AASHTO LRFD Guide Specifications for the Design of Pedestrian Bridges is not required.
8. Geometry: For project geometry see attached P&E sheets

Participation:

To be eligible to participate on this project pedestrian bridge producers must:

- Acknowledge receipt of this ITP
- Be on the FDOT List of Qualified Fabrication Facilities.
- Submit a response to this ITP on or before June 10, 2011 to the project EOR.

Submittal:

Provide completed pedestrian bridge data sheet as follows:

- Bearing Plate Dimensions Table – for each span provide bearing dimensions as shown to the nearest 1/8th inch.

- Bearing Plate Locations & Bridge Seat Elevations Table – for each substructure unit provide dimensions as shown to the nearest 1/8th inch and bridge seat elevation to the nearest 0.001 feet.
- Bridge Reactions Table – for each span provide loads as indicated to the nearest 0.1 kip.
- Company Contact Information Table – in the contact information block provide company name, address, contact person, phone number, and e-mail address.
- Florida PE Seal and Signature – provide seal and signature of Florida PE responsible for the work.

Submit response to:

John Doe, PE
XYZ Engineers, Inc.
123 East Main Street
Tampa, Florida 33607

By submitting a response to this invitation to participate the pedestrian bridge producer is agreeing to satisfy all project requirements listed above if selected.



LOCATION MAP

*CR 250 OVER RUBY CREEK PEDESTRIAN BRIDGE
JEFFERSON COUNTY FLORIDA
FPN 217664-1-52-01*

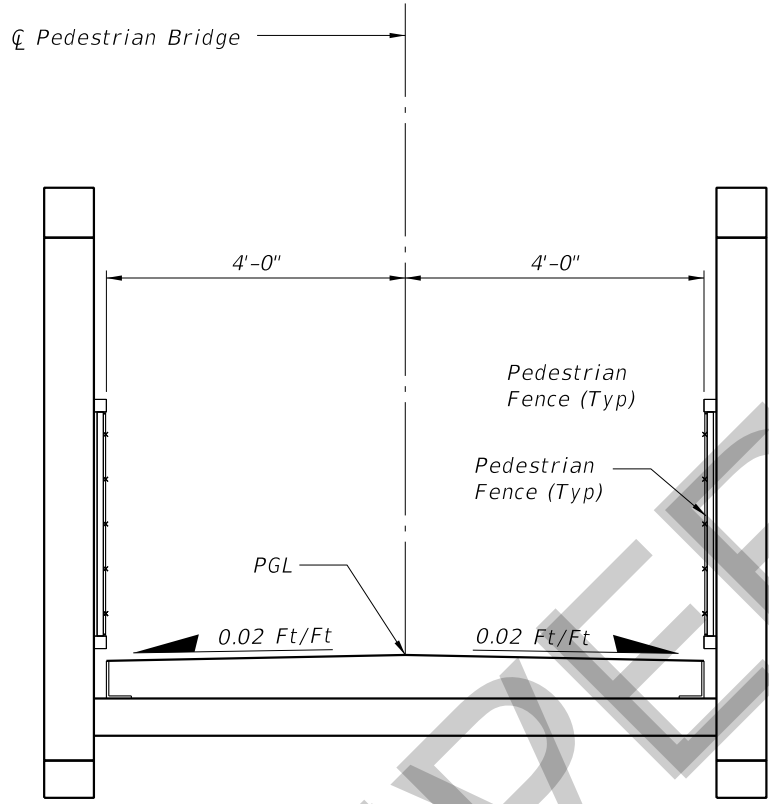

BRIDGE TYPICAL SECTION

(CR 250 Over Ruby Creek Pedestrian Bridge)

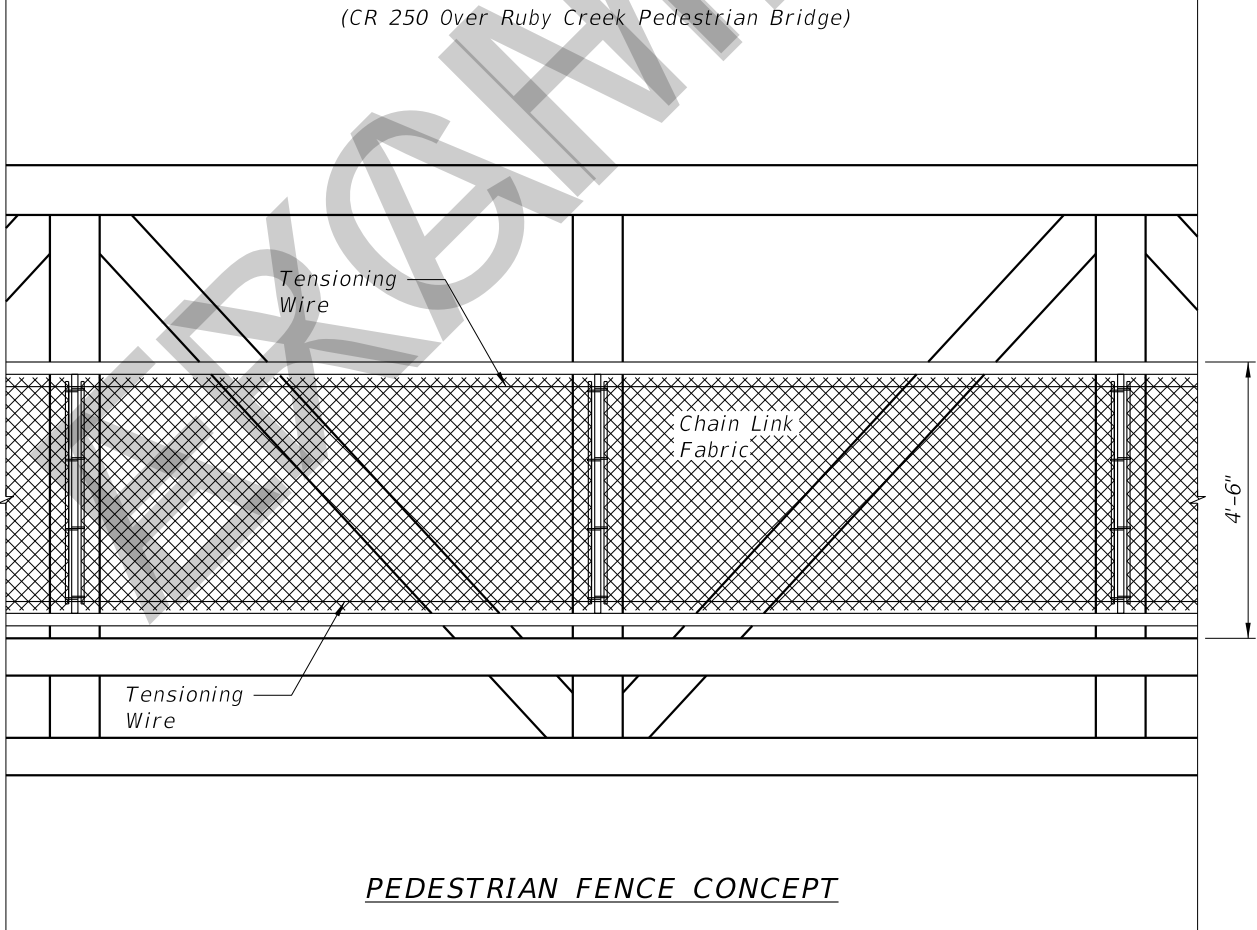

PEDESTRIAN FENCE CONCEPT

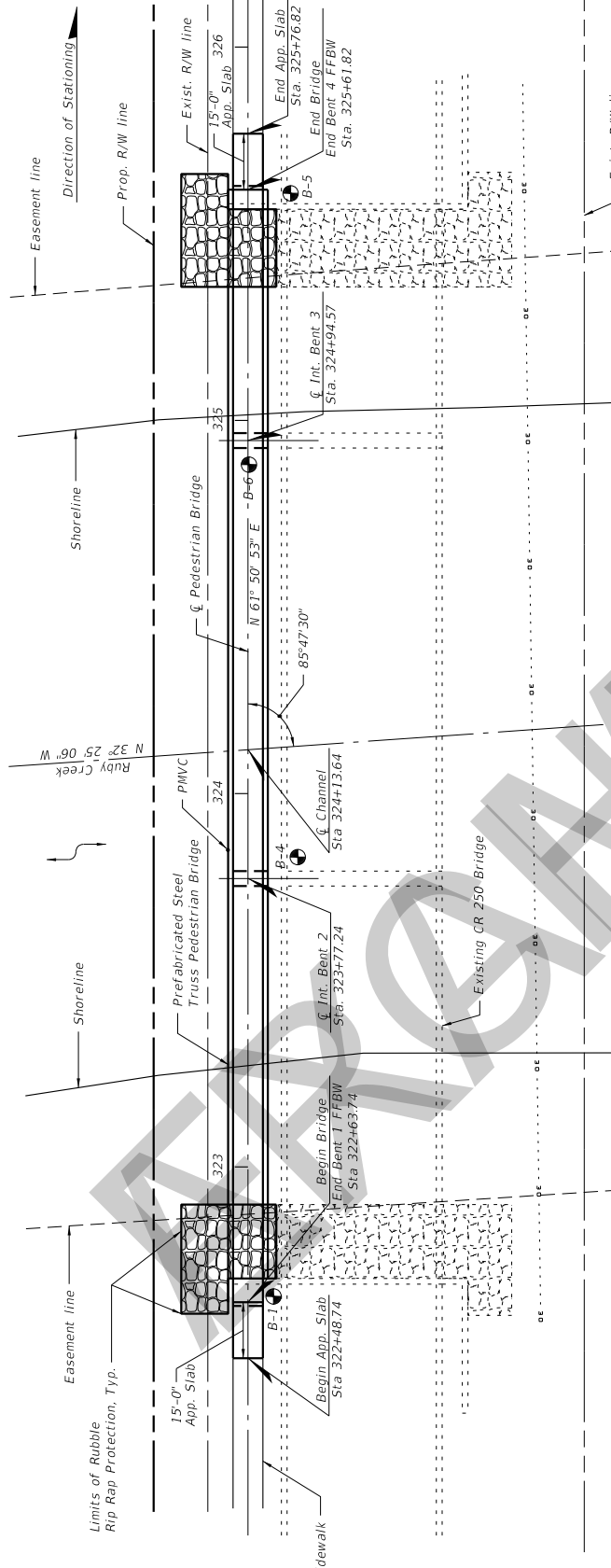
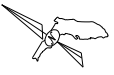

PLAN

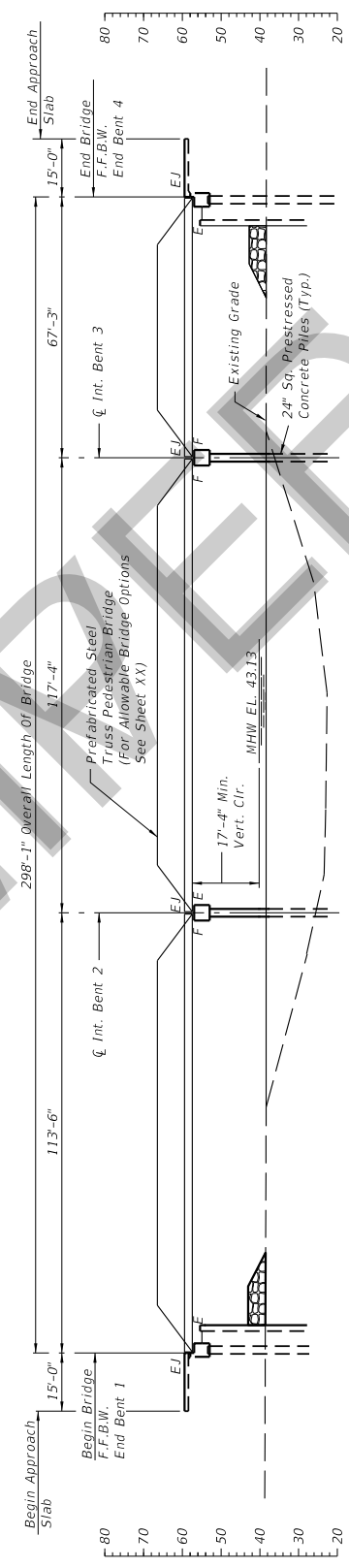

LEGEND

- PMVC - Point of Minimum Vertical Clearance
- FFBW - Front Face of Backwall
- MHW - Mean High Water
- B-4 - Approximate Location of SPT Boring
- EJ - Expansion Joint
- E - Expansion End
- F - Fixed End

DATE	BY	DATE	DESCRIPTION

DRAWN BY:		STATE OF FLORIDA	
CHECKED BY:		DEPARTMENT OF TRANSPORTATION	
DESIGNED BY:	ROAD NO.	COUNTY	FINANCIAL PROJECT ID
CHECKED BY:	CR 250	Jefferson	217664-1-52-01

SHEET TITLE:		PLAN AND ELEVATION (1 OF 2)	
PROJECT NAME:		CR 250 OVER RUBY CREEK PEDESTRIAN BRIDGE	
REF. DRAWG. NO.	SHEET NO.	DATE	PROJECT NO.

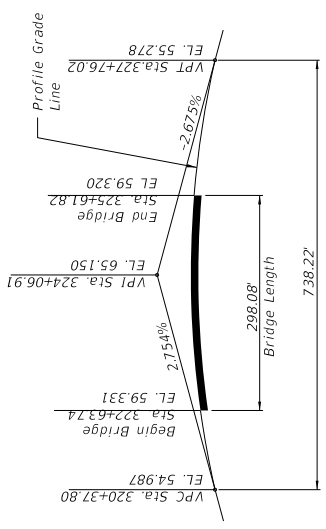

VERTICAL CURVE DATA

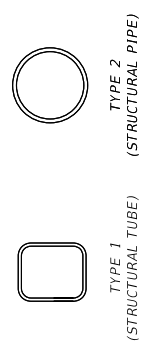

TRUSS MEMBER SHAPES

ALLOWABLE TRUSS MEMBER SHAPES	
TYPE 1	TYPE 2
X	X

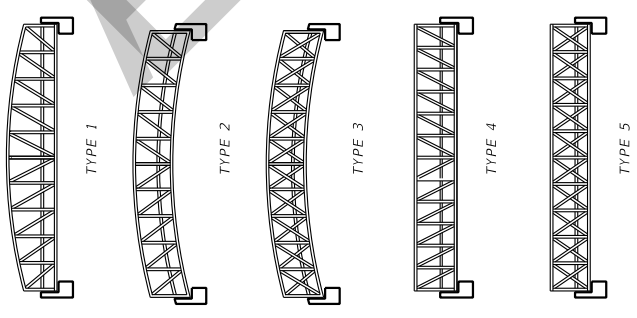

TRUSS CONFIGURATIONS

ALLOWABLE TRUSS CONFIGURATIONS				
TYPE 1	TYPE 2	TYPE 3	TYPE 4	TYPE 5
X			X	

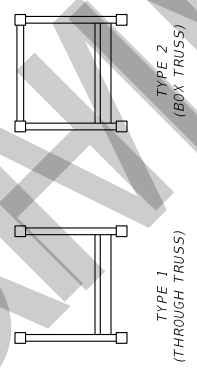

BRIDGE CROSS-SECTIONS

ALLOWABLE BRIDGE * CROSS-SECTIONS	
TYPE 1	TYPE 2
X	

* Through Truss bridges are acceptable only for spans less than or equal to 150'. For spans over 150' Box Truss Bridges are required.

NOTES

- Eligible Pedestrian Bridge Producers
Included in this plan set are Pedestrian Bridge Data Sheets submitted by bridge producers eligible to participate in this project. Producers who failed to submit a data sheet are excluded from participation. No Cost Savings Initiated Proposal shall be accepted for the truss superstructure portion of the project. Contact information for the eligible producers is included in the data sheets.
- Allowable Superstructure Options
All allowable superstructure options are indicated by an "X" in the tables on this sheet. For multi-span bridges use the same truss bridge options and depth of truss for each span.
- Shop Drawing Submittal
Prior to fabrication the EOR shall submit signed and sealed superstructure shop drawing, technical specifications, and calculations to the Engineer for review and approval.

REVISONS		DRAWN BY:		STATE OF FLORIDA		SHEET TITLE:	
DATE	BY	DATE	BY	DEPARTMENT OF TRANSPORTATION	PLAN AND ELEVATION (2 OF 2)		REF. DWG. NO.
DESCRIPTION		DESCRIPTION		ROAD NO.	FINANCIAL PROJECT ID	PROJECT NAME	SHEET NO.
				CR 250	217664-1-52-01	CR 250 OVER RUBY CREEK PEDESTRIAN BRIDGE	
				JEFFERSON COUNTY			

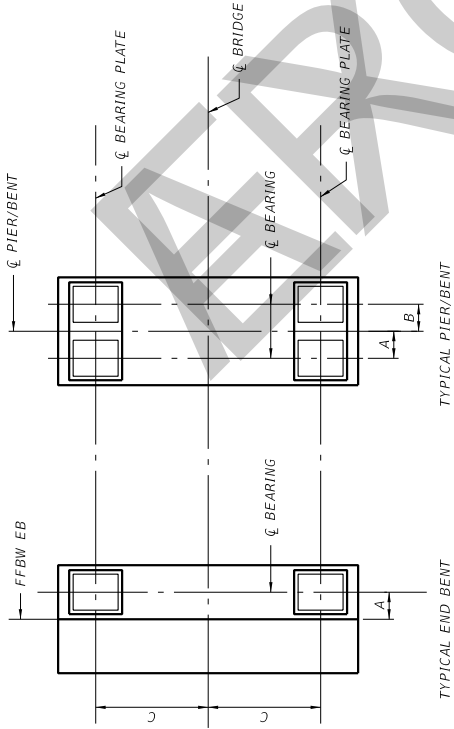

PLAN

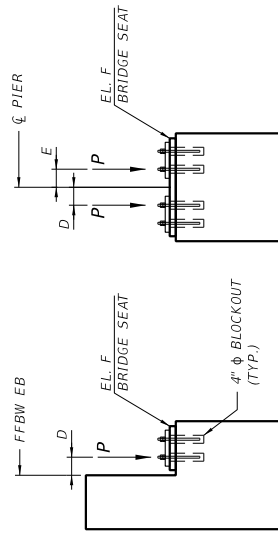

TYPICAL END BENT

TYPICAL PIER/BENT

ELEVATION

BEARING LOCATIONS & BRIDGE SEAT ELEVATIONS.						
BENT/PIER	A	B	C	D	E	F
	in.	in.	in.	in.	in.	ft.
1						
2						
3						
4						
5						

BEARING PLATE DIMENSIONS					
SPAN	G	H	J	K	
	in.	in.	in.	in.	in.
1					
2					
3					
4					

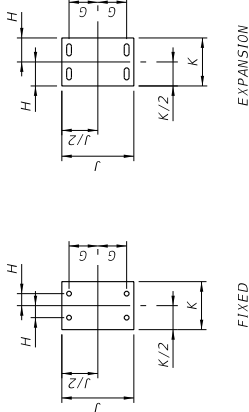

FIXED

EXPANSION

BEARING PLATE DETAILS

	BRIDGE REACTIONS													
	SPAN 1			SPAN 2			SPAN 3			SPAN 4				
	T (KIP)	L (KIP)	P (KIP)	T (KIP)	L (KIP)	P (KIP)	T (KIP)	L (KIP)	P (KIP)	T (KIP)	L (KIP)	P (KIP)	T (KIP)	L (KIP)
DEAD LOAD														
UNIFORM LIVE LOAD														
VEHICLE LOAD														
WIND WINDWARD UPLIFT														
WIND LEeward														
WIND TRANSVERSE														
WIND VERTICAL														
THERMAL														

1. P - UNFACTORED VERTICAL LOAD EACH BEARING PLATE (4 PER SPAN)
T - UNFACTORED TRANSVERSE LOAD EACH BENT/PIER (2 PER SPAN)
L - UNFACTORED LONGITUDINAL LOAD EACH BEARING PLATE (4 PER SPAN)
2. DOWNWARD VERTICAL LOADS ARE POSITIVE (+), UPWARD VERTICAL LOADS ARE NEGATIVE (-).
3. THE HORIZONTAL WIND LOAD ACTING AT THE C.G. OF THE TRUSS CREATES A TRANSVERSE SHEAR AND A VERTICAL COUPLE AT THE TOP OF EACH PIER/BEARING LOCATION.
4. DESIGN SPECIFICATIONS
• FDOT STRUCTURES MANUAL, CURRENT EDITION AND SUPPLEMENTS THERETO.
• AMERICAN ASSOCIATION OF STATE HIGHWAY AND TRANSPORTATION OFFICIALS (ASHTO) LOAD AND RESISTANCE FACTOR (LRFD) BRIDGE DESIGN SPECIFICATIONS, CURRENT EDITION AND SUPPLEMENTS THERETO.
• ASHTO LRFD GUIDE SPECIFICATIONS FOR THE DESIGN OF PEDESTRIAN BRIDGES, CURRENT EDITION
• FDOT PLANS PREPARATION MANUAL, CURRENT EDITION.
5. CONSTRUCTION SPECIFICATIONS
• FDOT STANDARD SPECIFICATIONS FOR ROAD AND BRIDGE CONSTRUCTION
• CURRENT EDITION AND SUPPLEMENTS THERETO.

REVISIONS		
DATE	BY	DESCRIPTION

DRAWN BY:	STATES OF FLORIDA	SHEET TITLE:	PEDESTRIAN BRIDGE DATA
CHECKED BY:	DEPARTMENT OF TRANSPORTATION	PROJECT NO.:	CR 250 OVER RUBY CREEK PEDESTRIAN BRIDGE
DESIGNED BY:	ROAD NO.:	PROJECT NAME:	
CHECKED BY:	CR 250	JEFFERSON	217664-1-52-01
	COUNTY:		

REF. DRAWING NO.	
SHEET NO.	BP-01